

MAR-2000

Quick Installation Guide

First Edition, June 2014

Overview

The MAR-2000 is a multi-WAN router with 802.11n, GPS, and 3G GSM/HSPA+ interfaces. It features 2 RS-232/422/485 serial ports, 2 Ethernet ports, 4 digital input channels, 4 digital output channels, a CompactFlash socket, and 2 USB 2.0 ports. The MAR-2000 is particularly well-suited for rolling stock or other vehicle applications, giving a solid, convenient foundation for configuring an intelligent, cost-effective, multiple-WAN mobile communications environment.

Package Checklist

- 1 MAR-2000 embedded computer
- Wall-mounting kit
- DIN rail mounting kit
- CBL-4PINDB9F-100: 4-pin pin header to DB9 female console port cable, 100 cm
- Quick installation guide (this guide)
- Documentation and software CD
- Warranty card

Note: Please notify your sales representative if any of the above items are missing or damaged.

Panel Layout

Refer to the following figures for the panel layouts.

Front View

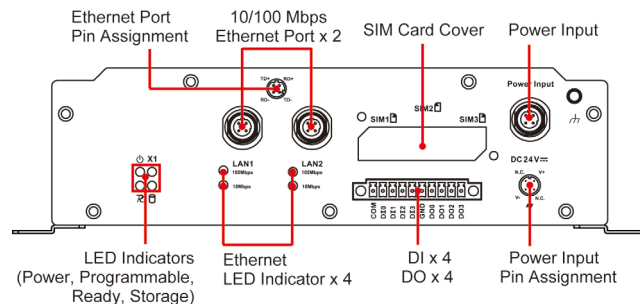

Rear View

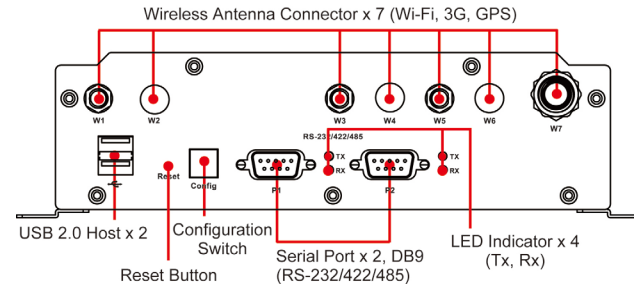

LED Indicators

The following table describes the LED indicators located on the front and rear panels of the MAR-2000.

LED Name	LED Color	LED Function
Power	Green	Power is on and functioning normally
	Off	Power is off, or power error
Storage	Yellow	CF card is detected
	Off	CF card is not detected
Ready	Green	The system is ready
	Off	The system is not ready
X1 (programmable)	Green	Programmable: no default definition
	Off	Programmable: no default definition
LAN1, LAN2	Green	100 Mbps Ethernet mode
	Yellow	10 Mbps Ethernet mode
	Off	No activity
P1 Tx, P2 Tx (on the right of the DB9 port)	Green	Serial port transmitting data
	Off	Serial port not transmitting data
P1 Rx, P2 Rx (on the right of the DB9 port)	Yellow	Serial port receiving data
	Off	Serial port not receiving data

Installing the Mounting Kits

Wall and cabinet mounts

The two metal brackets included with the MAR-2000 can be used to attach it to a wall or the inside of a cabinet. Using two screws per bracket, first attach the brackets to the bottom of the MAR-2000. Next, use two screws (M3 type, torque 4.5±0.5 kgf-cm) per bracket to attach the MAR-2000 to a wall or cabinet.

DIN rail assemblies

An aluminum DIN rail mounting assembly is included in the package. When attaching the rail assembly to the MAR-2000, orient the stiff metal spring towards the top.

STEP 1: Insert the top of the DIN rail into the slot just below the stiff metal spring.

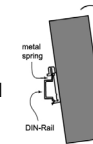

STEP 2: The mounting assembly should then snap into place, as shown.

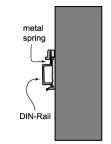

To remove the MAR-2000 from the DIN rail, reverse steps 1 and 2 above.

Connector Description

Power Connector

Connect the 24 VDC power line to the MAR-2000's power input with the M12 connector. When the MAR-2000 system is ready, the READY LED will display a steady green color.

Grounding the MAR-2000

Grounding and wire routing help limit the effects of noise due to electromagnetic interference (EMI). Run the ground connection from the ground screw to the grounding surface prior to connecting the power.



ATTENTION

This product is intended to be mounted to a well-grounded mounting surface, such as a metal panel.

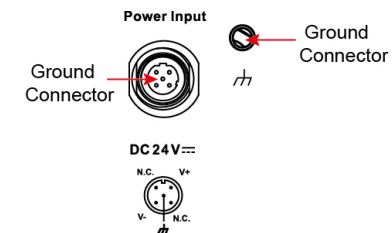

There are two ground connectors on the front panel of the MAR-2000. One is located at the middle pin of the power input, the other is beside the power input. Use either connector for grounding.

SIM Card

The MAR-2001-T supports 2 cellular modules, and the MAR-2002-T supports 3 cellular modules. Unscrew the SIM card cover and insert the SIM card in the desired slot.

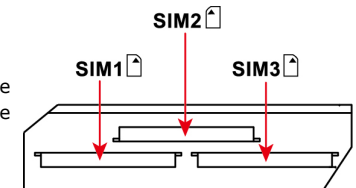

P/N: 1802020002010



Ethernet Port

The MAR-2000 comes with 2 10/100 Mbps Ethernet ports with M12 connectors.

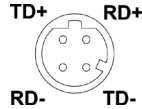

Serial Port

The 2 serial ports (P1 and P2) use DB9 male connectors. Each port can be configured for use on RS-232, RS-422, or RS-485 networks from the MAR-2000's management web page. The pin assignments are shown in the following table:

Pin	RS-232	RS-422	RS-485 (4-wire)	RS-485 (2-wire)
1	DCD	TxDA(-)	TxDA(-)	-
2	RxD	TxDB(+)	TxDB(+)	-
3	TxD	RxDB(+)	RxDB(+)	DataB(+)
4	DTR	RxDA(-)	RxDA(-)	DataA(-)
5	GND	GND	GND	GND
6	DSR	-	-	-
7	RTS	-	-	-
8	CTS	-	-	-

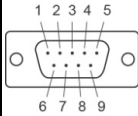

Antenna

The MAR-2000 comes with built-in GPS and 3G GSM/HSPA+ modules. The following chart indicates the default configuration of antenna mounts:

MAR-2001-T

W1	W2	W3	W4	W5	W6	W7
WLANB	WLANB	WLANA	WLANA	3G #2	3G #1	GPS

MAR-2002-T

W1	W2	W3	W4	W5	W6	W7
WLANA	WLANA	N/A	3G #3	3G #2	3G #1	GPS

DI, DO

The MAR-2000 has 4 digital output channels and 4 digital input channels. The MAR-2000 Hardware User's Manual has detailed pinout and wiring diagrams.

Reset Button

Press and hold the **Reset** button continuously for at least 5 seconds to reload the factory default configuration. After the factory default configuration has been loaded, the system will reboot automatically. The Ready LED maintains a steady glow once the system has rebooted.

CompactFlash

The MAR-2000 has a single CompactFlash type I/II slot for memory expansion. The CF card can be accessed by unscrewing the panel located on the bottom of the MAR-2000.

The mount point for the CompactFlash filesystem is /dev/sda.

WARNING

Be sure to power off the computer before inserting or removing the CompactFlash card.

Console Port

The RS-232 console port is a 4-pin header connector located on the underside of the motherboard above the CF card socket. As above, use a screwdriver to remove the panel protecting the CF card to access the 4-pin RS-232 connector. This serial port is used to access the console terminal, and is useful for viewing boot messages, file system logs, and error messages. Use the CBL-4PINDB9F-100 cable included with the MAR-2000 to connect a PC to the MAR-2000's serial console port.

USB

The MAR-2000 computer features 2 USB 2.0 ports for external storage expansion.

Powering on the MAR-2000

To power on the MAR-2000, connect the power cable to the M12 connector and then connect the power adapter.

ATTENTION

The **shielded ground** should be connected to the center pin of the power input connector.

Note that it takes approximately five minutes for the system to get ready. Once the system is ready, the **Ready** LED will light up.

Connecting to the MAR-2000

There are three ways to connect the MAR-2000 to a PC: through the MAR-2000 management web page, the serial console port, or by SSH over the network. The COM settings for the serial console port are: **Baudrate=115200 bps, Parity=None, Data bits=8, Stop bits =1, Flow Control=None.**



ATTENTION

Remember to choose the **VT100** terminal type. To connect a PC to the serial console, use the CBL-4PINDB9F-100 cable that shipped with your MAR-2000.

To use SSH and the MAR-2000 management web page, you will need to know the MAR-2000's IP address and netmask. The default LAN settings are shown below. For initial configuration, you may find it convenient to use a crossover Ethernet cable to connect directly from the PC to the MAR-2000.

	Default IP Address	Netmask
LAN 1	192.168.3.127	255.255.255.0
LAN 2	192.168.4.127	255.255.255.0

Once the MAR-2000 is powered on and the **Ready** LED has lit up, you can open the MAR-2000 management web page. The default **Login** and **Password**:

Login: admin
Password: admin

NOTE For additional configuration information, refer to the MAR-2000 Hardware User's Manual.

MOXA® www.moxa.com/support

The Americas: +1-714-528-6777 (toll-free: 1-888-669-2872)
Europe: +49-89-3 70 03 99-0
Asia-Pacific: +886-2-8919-1230
China: +86-21-5258-9955 (toll-free: 800-820-5036)

© 2015 Moxa Inc., All Rights Reserved